

TC-FX110

SERVICE MANUAL

US Model
 Canadian Model
 AEP Model
 UK Model
 E Model

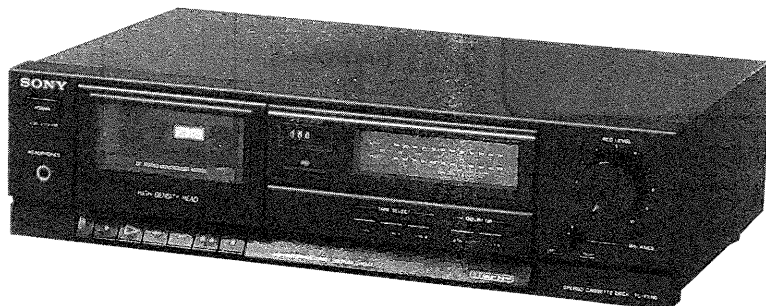

Model Name Using Similar Mechanism	TC-FX100
Tape Transport Mechanism Type	TCM-YM47CW-62

SPECIFICATIONS

Recording system 4-track 2-channel stereo
 Fast winding Approx. 120 sec. (with C-60 cassette)
 Bias AC Bias
 Signal-to-noise ratio (NAB, at peak level)

Cassette	Dolby NR switch		
	OFF	B-TYPE ON	C-TYPE ON
TYPE IV (Sony METAL-ES)	58 dB	65 dB	71 dB
TYPE II (Sony UX-S)	56 dB	63 dB	69 dB
TYPE I (Sony HF-S)	54 dB	61 dB	67 dB

Total harmonic distortion 1.0% (with Sony METAL-ES cassettes)

Frequency response (DOLBY NR OFF)

TYPE IV cassette (Sony METAL-ES)	30-15,000 Hz (±3 dB, DIN) 30-13,000 Hz (OVU recording)
TYPE II cassette (Sony UX-S)	30-14,000 Hz (±3 dB, DIN)
TYPE I cassette (Sony HF-S)	30-13,000 Hz (±3 dB, DIN)

Wow and flutter 0.12% WRMS (NAB)
±0.2% (DIN)

Inputs

Line inputs (phono jacks)	Sensitivity	77.5 mV (-20 dB)
	Input impedance	50k ohms

Outputs

Line outputs (phono jacks)	Rated output level	0.44 V (-5 dB) at a load impedance of 47k ohms
	Load impedance	Over 10k ohms
Headphone output (stereo phone jack)	Output level	0.4 mW at a load impedance of 32 ohms

General

Power requirements
 120V AC, 60Hz (US/Canadian model)
 220V AC, 50/60Hz (AEP model)
 240V AC, 50Hz (UK model)
 110-120, 220-240V AC, 50/60Hz (E model)



Power consumption 12W (US/Canadian/AEP/UK model)
13W (E model)
 Dimensions Approx. 430 × 118 × 286 mm (w/h/d)
(17 × 4 3/4 × 11 3/8 inches)
including projecting parts and controls
 Weight Approx. 3.5 kg (7 lbs 12 oz)

Supplied accessory

Audio connecting cord (2)

Dolby noise reduction manufactured under license from Dolby Laboratories Licensing Corporation. "DOLBY" and the double-D symbol  are trademarks of Dolby Laboratories Licensing Corporation.

SAFETY-RELATED COMPONENT WARNING!!

COMPONENTS IDENTIFIED BY MARK  OR DOTTED LINE WITH MARK  ON THE SCHEMATIC DIAGRAMS AND IN THE PARTS LIST ARE CRITICAL TO SAFE OPERATION. REPLACE THESE COMPONENTS WITH SONY PARTS WHOSE PART NUMBERS APPEAR AS SHOWN IN THIS MANUAL OR IN SUPPLEMENTS PUBLISHED BY SONY.

ATTENTION AU COMPOSANT AYANT RAPPORT À LA SÉCURITÉ!

LES COMPOSANTS IDENTIFIÉS PAR UNE MARQUE  SUR LES DIAGRAMMES SCHÉMATIQUES ET LA LISTE DES PIÈCES SONT CRITIQUES POUR LA SÉCURITÉ DE FONCTIONNEMENT. NE REMPLACER CES COMPOSANTS QUE PAR DES PIÈCES SONY DONT LES NUMÉROS SONT DONNÉS DANS CE MANUEL OU DANS LES SUPPLÉMENTS PUBLIÉS PAR SONY.

STEREO CASSETTE DECK
SONY®



SECTION 1 GENERAL

MODEL IDENTIFICATION

- Specification Label Printed on Back Panel -

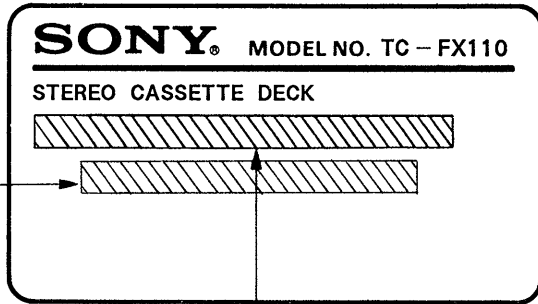

US/Canadian model: AC 120V 60Hz 12W
 AEP model: AC 220V~50/60Hz
 UK model: AC 240V~50/60Hz
 E model: AC 110-120V, 220-240V~50
 /60Hz 13W

(S) (D) (N) (S) (F1): AE2 only

1-1. LOCATION AND FUNCTION OF CONTROLS

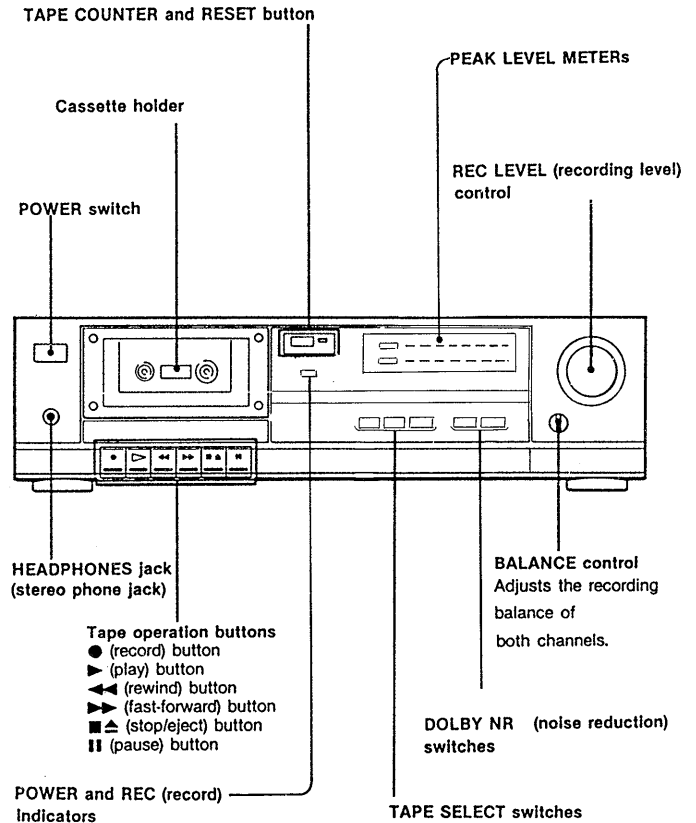

SAFETY CHECK-OUT

After correcting the original service problem, perform the following safety check before releasing the set to the customer:

Check the antenna terminals, metal trim, "metallized" knobs, screws, and all other exposed metal parts for AC leakage. Check leakage as described below.

LEAKAGE TEST

The AC leakage from any exposed metal part to earth ground and from all exposed metal parts to any exposed metal part having a return to chassis, must not exceed 0.5 mA (500 microampers). Leakage current can be measured by any one of three methods.

1. A commercial leakage tester, such as the Simpson 229 or RCA WT-540A. Follow the manufacturers' instructions to use these instruments.
2. A battery-operated AC milliammeter. The Data Precision 245 digital multimeter is suitable for this job.

3. Measuring the voltage drop across a resistor by means of a VOM or battery-operated AC voltmeter. The "limit" indication is 0.75 V, so analog meters must have an accurate low-voltage scale. The Simpson 250 and Sanwa SH-63Trd are examples of a passive VOM that is suitable. Nearly all battery operated digital multimeters that have a 2V AC range are suitable. (See Fig. A)

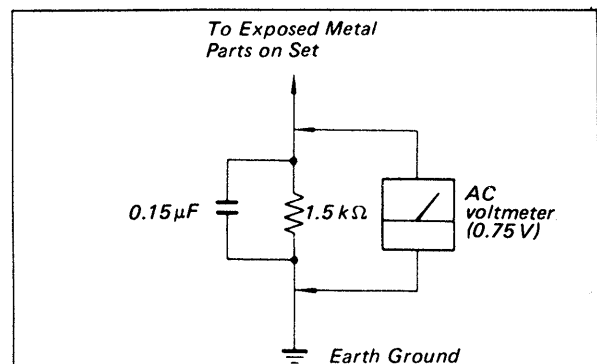

Fig. A. Using an AC voltmeter to check AC leakage.

SECTION 2 MECHANICAL MEASUREMENT

PRECAUTION

1. Clean the following parts with a denatured-alcohol-moistened swab:

record/playback head	pinch roller
erase head	rubber belts
capstan	idlers
2. Demagnetize the record/playback head with a head demagnetizer.
3. Do not use a magnetized screwdriver for the adjustments.
4. After the adjustments, apply suitable locking compound to the parts adjusted.
5. The adjustments should be performed with the rated power supply voltage unless otherwise noted.

2-1. TORQUE MEASUREMENT

Torque	Torque	Meter reading
FWD	CQ-102C	30 to 70g·cm (0.43 to 0.97oz·inch)
FWD Back tension	CQ-102C	1.5 to 5.5g·cm (0.02 to 0.07oz·inch)
FF, REW	CQ-201B	63g·cm or more (0.87oz·inch or more)

SECTION 3 ELECTRICAL ADJUSTMENT

Note: The adjustment should be performed in the order given in this service manual.
The adjustments should be performed for both L-CH and R-CH.

- Switches and controls should be set as follows unless otherwise specified.
DOLBY NR switch: OFF
- Standard Record:
Deliver the standard input signal level to the input jack and set the REC LEVEL control to obtain the standard output signal level.

—Record Mode—

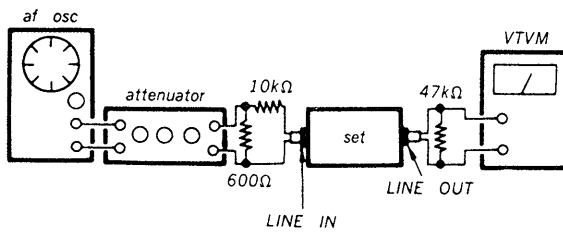

Standard Input Level

	LINE IN
source impedance	10kΩ
input level	0.25V (-10dB)

Standard Output Level

	LINE OUT
load impedance	47kΩ
output level	0.44V (-5dB)

3-1. RECORD/PLAYBACK HEAD AZIMUTH ADJUSTMENT

Procedure:

1. Mode: playback

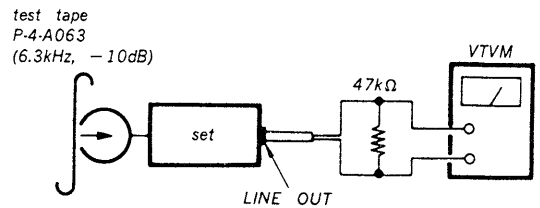

2. Turn the adjustment screw for the maximum output levels. If these levels do not match, turn the adjustment screw until both of output levels match together within 1dB.

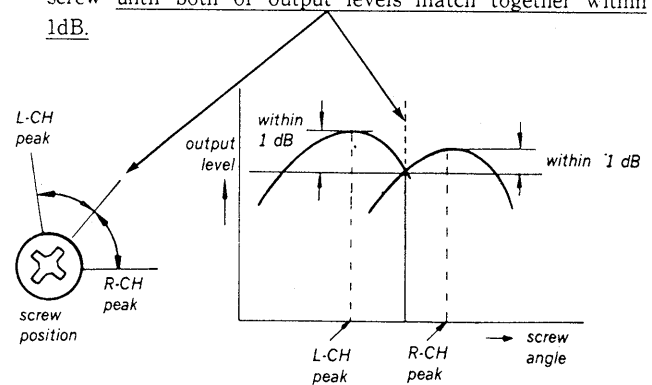

3. Phase Check
Mode: playback

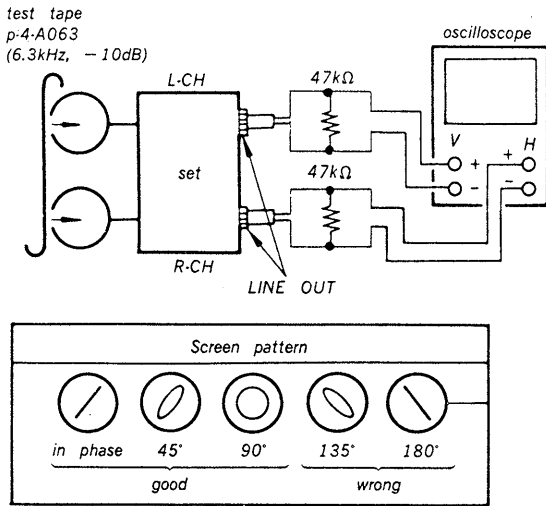

Adjustment Location:

—Record/Playback head—

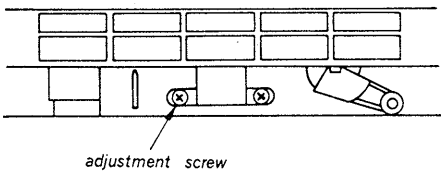

3-2. PLAYBACK LEVEL ADJUSTMENT

Procedure:

1. Mode: playback

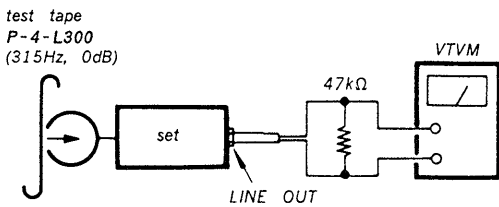

Adjust RV131 (L-CH) and RV213 (R-CH) so that the specification is met.

Specification:

LINE OUT level : 0.130 to 0.146V
(-15 ± 0.5dBs)

Level difference between channels: less than 0.5dB

Check that the LINE OUT level does not change in playback mode while changing the mode from playback to stop several times.

3-3. RECORD BIAS ADJUSTMENT

Setting:

REC LEVEL control: standard record
(See page 3)

Procedure:

1. Mode: record

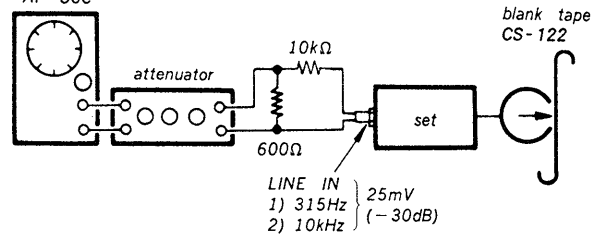

2. Mode: playback

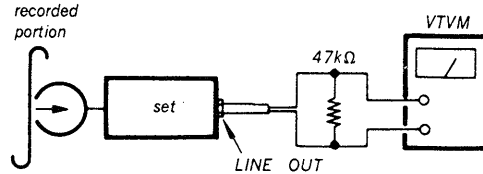

Confirm that the 10kHz playback output is 0 ± 0.5 dB relative to the 315Hz output. If necessary, adjust CT381-1 (L-CH), CT381-2 (R-CH) and repeat the steps given above.

3-4. RECORD LEVEL ADJUSTMENT

Setting:

REC LEVEL control: standard record
(See page 3)

Procedure:

1. Mode: record

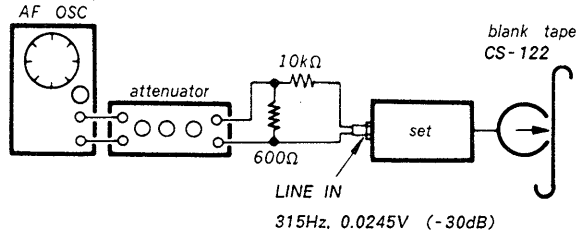

2. Mode: playback

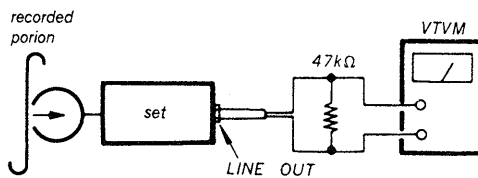

SECTION 4 DIAGRAMS

- Playback the signal recorded in step 1.
Confirm that the signal level is within the specification below. If necessary, adjust RV141 (L-CH), RV241 (R-CH) and repeat the step 1-3.

Specification :
 LINE OUT level : 0.0411 to 0.0462V
 (-25 ± 0.5dBs)

3-5. ADJUSTMENT LOCATION

Audio board (conductor side)

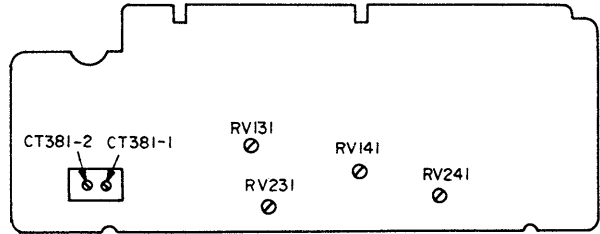

4-1. SEMICONDUCTOR LEAD LAYOUTS

CX20187

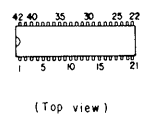

**2SC1815Y
2SC945P**



IR2E31A

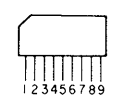

**US1060M
10E2**

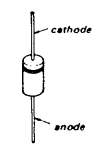

M5218L

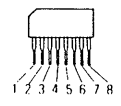

SEL1210S

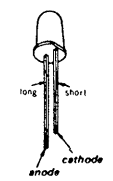

**BN1L3Z
DTC143TS
DTA114ES
DTA144ES
2SA1175HFE
2SC2785HFE**

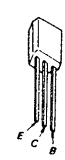

**SEL4214S
SEL4414ED**

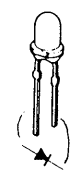

**2SB1274
2SD2012**

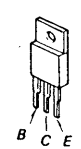

4-2. PRINTED WIRING BOARDS

• Semiconductor Location

Ref. No.	Location
D171	B-10
D172	B-9
D173	B-9
D174	B-8
D175	B-8
D176	B-10
D271	B-10
D272	B-9
D273	B-9
D274	B-8
D275	B-8
D276	B-10
D381	C-9
D382	D-13
D383	D-8
D384	C-10
D385	C-4
D386	C-10
D387	C-7
D388	C-12
D389	B-10
D401	G-7
D402	G-7
D403	G-7
D404	G-7
D405	G-6
IC171	B-9
IC271	C-9
IC311	D-4
IC331	D-11
IC341	D-7
IC361	B-11
IC381	C-11
Q131	C-10
Q141	D-7
Q161	B-7
Q231	E-10
Q241	D-6
Q261	C-8
Q381	C-13
Q382	C-13
Q383	C-12
Q384	C-9
Q388	C-7
Q389	C-9
Q401	G-5
Q404	G-5
Q406	G-6

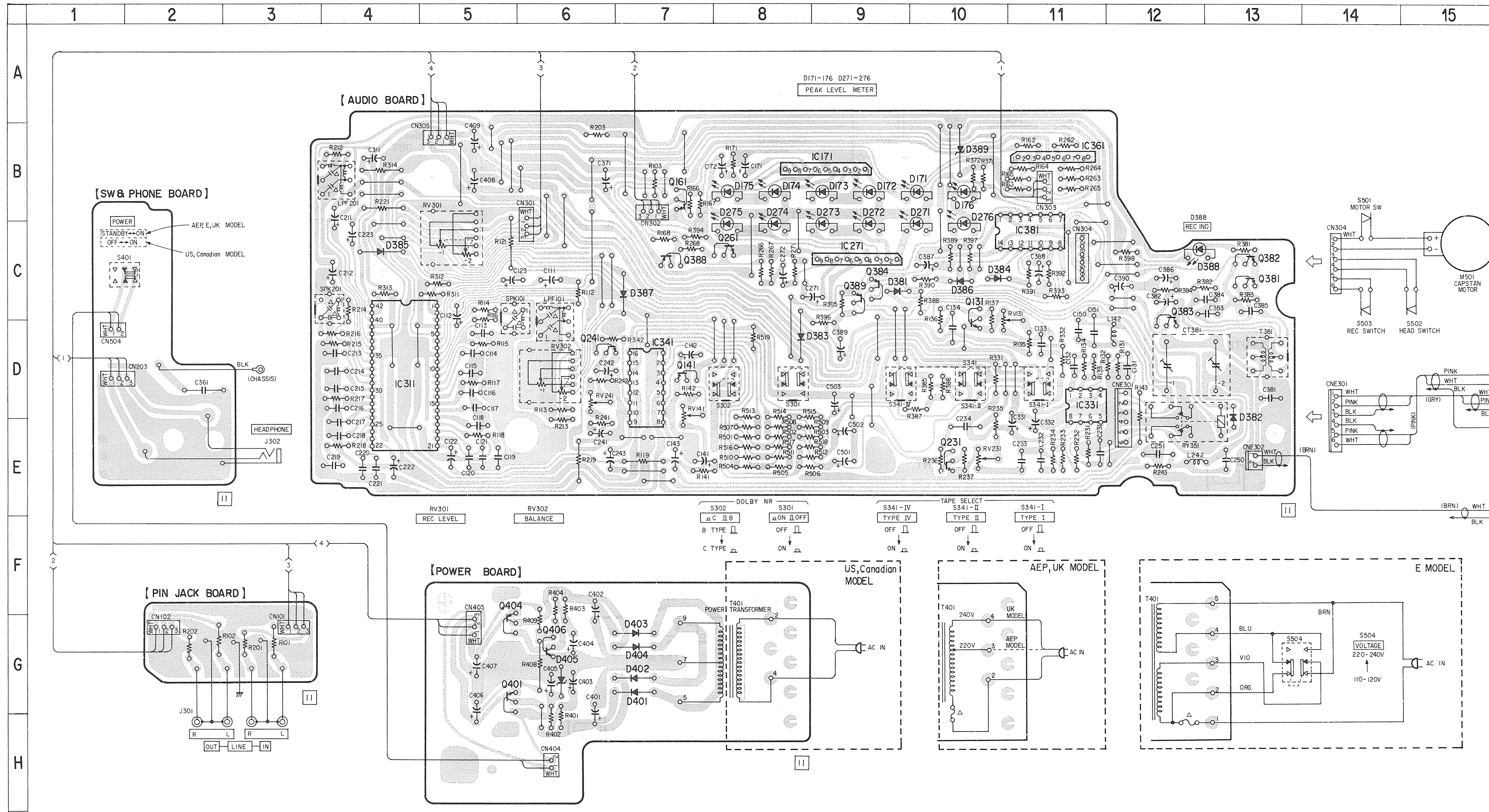

Note:

- Color code or sleeving over the end of the jacket.

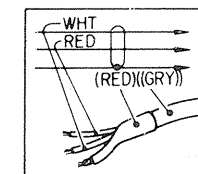

- ○ : parts extracted from the component side.
- □ : indicates side identified with part number.

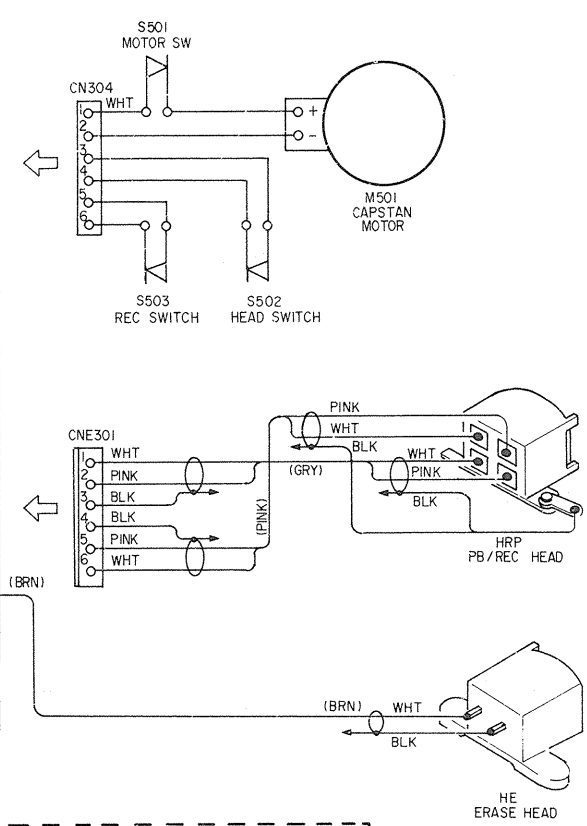

4-3. SCHEMATIC DIAGRAM

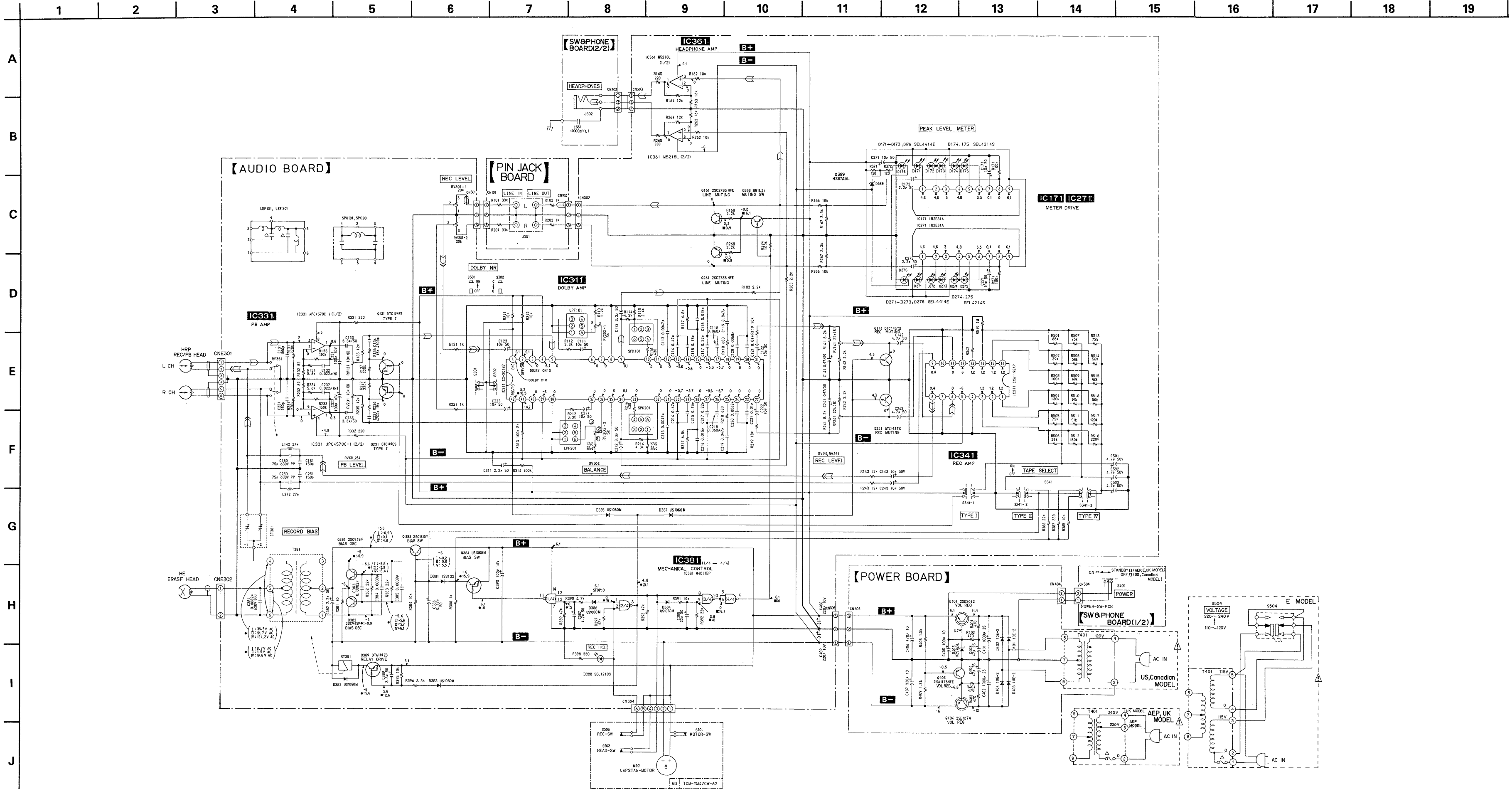

Note:
 • All capacitors are in μF unless otherwise noted. pF : μpF
 50WV or less are not indicated except for electrolytics
 and tantalums.
 • All resistors are in Ω and $\frac{1}{4}\text{W}$ or less unless otherwise
 specified.

Note:
 The components identified by mark Δ or dot-
 ted line with mark Δ are critical for safety.
 Replace only with part
 number specified.

• Switch

Ref No.	Switch	Position
S301	DOLBY NR ON/OFF	OFF
S302	DOLBY NR TYPE B/C	TYPE-B
S341-1	TAPE SELECT TYPE-I	ON
S341-2	TAPE SELECT TYPE-II	OFF
S341-3	TAPE SELECT TYPE-IV	OFF
S401	POWER	STANDBY (OFF)
S501	MOTOR	OFF
S502	HEAD	OFF
S503	REC	OFF
S504	VOLTAGE (E MODEL)	110-120V

- **B+** : B+ Line
- **B-** : B- Line
- \square : adjustment for repair.
- AC voltage readings in the bias oscillator with a VTVM.
- Voltage and waveforms are dc with respect to ground
 under no-signal (detuned) conditions.
 no mark : PLAY
 ■ : STOP
 ● : REC
- Voltages are taken with a VOM (50 k Ω /V).
 Voltage variations may be noted due to normal produc-
 tion tolerances.
- Signal path.
 Σ : PB
 Δ : REC

SECTION 5 EXPLODED VIEWS

NOTE:

- The mechanical parts with no reference number in the exploded views are not supplied.
- The construction parts of an assembled part are indicated with a collation number in the remark column.
- Items marked "★" are not stocked since they are seldom required for routine service. Some delay should be anticipated when ordering these items.

- Due to standardization, parts with part number suffix -XX and -X may be different from the parts specified in the components used on the set.
- Color Indication of Appearance Parts
Example:
(RED) ... KNOB, BALANCE (WHITE)
 ↑ ↑
Cabinet's Color Parts Color

The components identified by mark ▲ or dotted line with mark ▲ are critical for safety. Replace only with part number specified.

Les composants identifiés par une marque ▲ sont critiques pour la sécurité. Ne les remplacer que par une pièce portant le numéro spécifié.

(1) CABINET AND MAIN SECTION

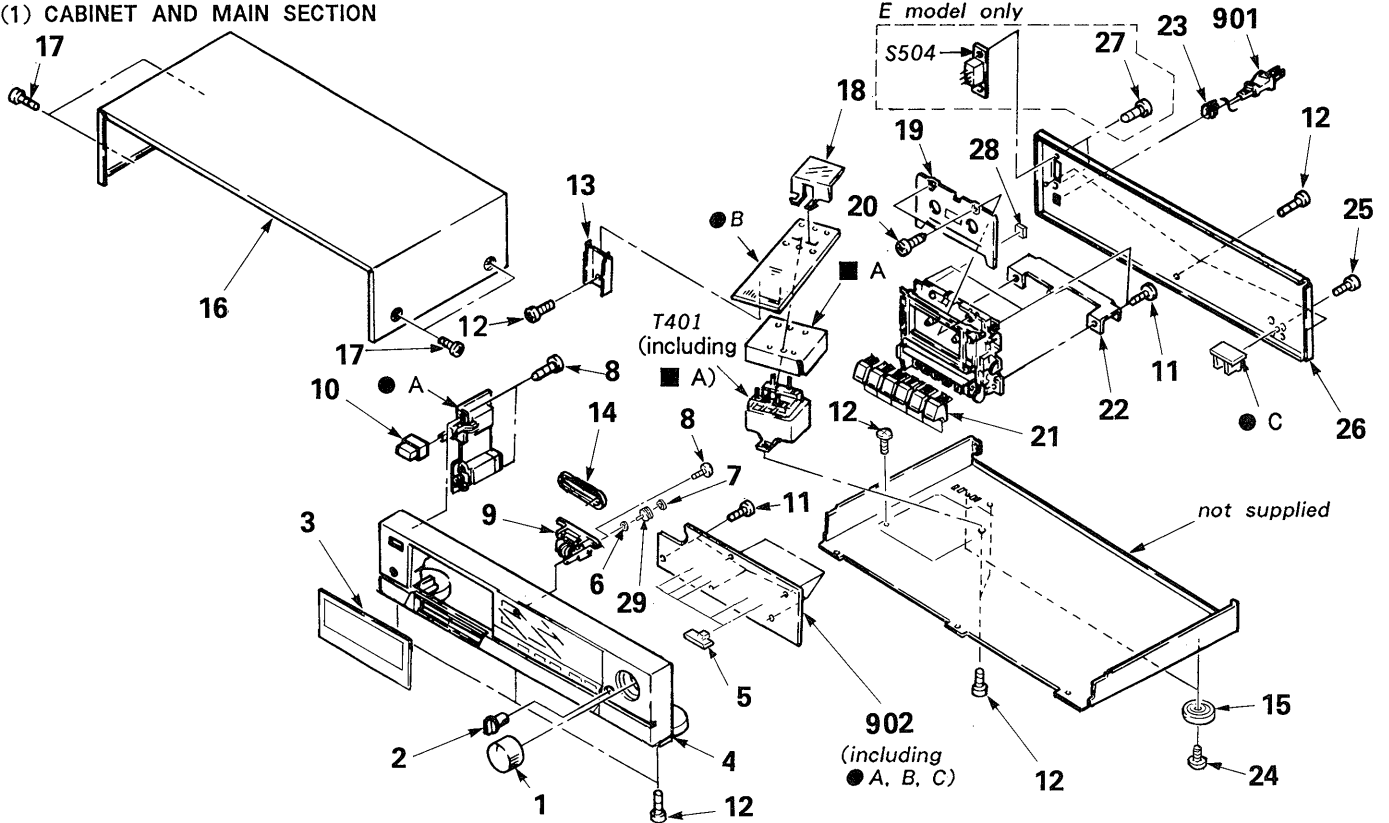

No.	Part No.	Description	Remarks	No.	Part No.	Description	Remarks
1	3-346-380-01	KNOB (VOL)		23	3-703-244-00	(AEP,West Germany,UK) ...BUSHING (2104), CORD	
2	3-327-846-01	KNOB		3-703-571-11	(US,Canadian)...BUSHING (S) (4516), CORD		
3	X-3318-960-1	LID ASSY, CASSETTE		24	7-682-548-04	SCREW +BVT 3X8 (S)	
4	X-3318-961-1	(US,Canadian)...PANEL ASSY, FRONT		25	7-621-849-00	SCREW, TAPPING	
	X-3318-962-1	(AEP,West Germany,UK,E) ...PANEL ASSY, FRONT		26	*3-327-877-01	(US,Canadian)...PANEL, BACK	
5	3-350-810-01	BUTTON			*3-327-877-11	(AEP,West Germany)...PANEL, BACK	
6	3-558-708-11	WASHER, STOPPER			*3-327-877-21	(AE2).....PANEL, BACK	
7	3-701-437-11	WASHER			*3-327-877-31	(E).....PANEL, BACK	
8	4-928-635-01	SCREW, +BV (2.6X8) TAPPING			*3-327-877-41	(UK).....PANEL, BACK	
9	1-548-596-61	COUNTER, TAPE (MIDDLE TYPE)		27	7-686-534-19	(E)...SCREW +BTP 2.6X8 TYPE2 N-S	
10	4-917-460-01	KNOB, POWER		28	3-553-567-00	CUSHION	
11	4-928-635-21	SCREW, +BV (2.6X10) TAPPING		29	3-549-452-00	PULLEY, SHUT-OFF	
12	7-682-547-04	SCREW +BVT 3X6 (S)		901	▲ 1-551-188-XX	(E).....CORD, POWER	
13	*3-309-144-21	HEAT SINK			▲ 1-551-506-XX	(US,Canadian)...CORD, POWER	
14	3-527-150-XX	BELT, CAPSTAN			▲ 1-555-795-00	(AEP,West Germany) ...CORD, POWER, EULO PLUG	
15	X-4885-935-1	(AEP,West Germany,UK)...FOOT ASSY			▲ 1-556-035-00	(UK).....CORD, POWER	
	X-4911-201-1	(US,Canadian,E).....FOOT ASSY		902	*A-2056-442-A	MOUNTED PCB, AUDIO	
16	3-332-578-42	CASE			*1-630-283-11	PC BOARD, AUDIO	
17	3-704-366-01	SCREW (CASE) (M3X8)		S504	▲ 1-552-535-00	(E)...SWITCH, POWER & VOLTAGE CHANGE	
18	*3-327-872-01	COVER (TRANSFORMER)		T401	▲ 1-449-388-11	(E).....TRANSFORMER, POWER	
19	4-914-974-01	PLATE, ORNAMENTAL, CASSETTE		T401	▲ 1-449-390-11	(AEP,West Germany,UK) ...TRANSFORMER, POWER	
20	7-685-133-19	SCREW +P 2.6X6 TYPE2 NON-SLIT		T401	▲ 1-449-593-11	(US,Canadian).....TRANSFORMER, POWER	
21	3-349-043-01	BUTTON (BLOCK B)					
22	*3-346-376-01	REINFORCEMENT, MD					

(2) MECHANISM SECTION
(TCM-YM47CW-62)

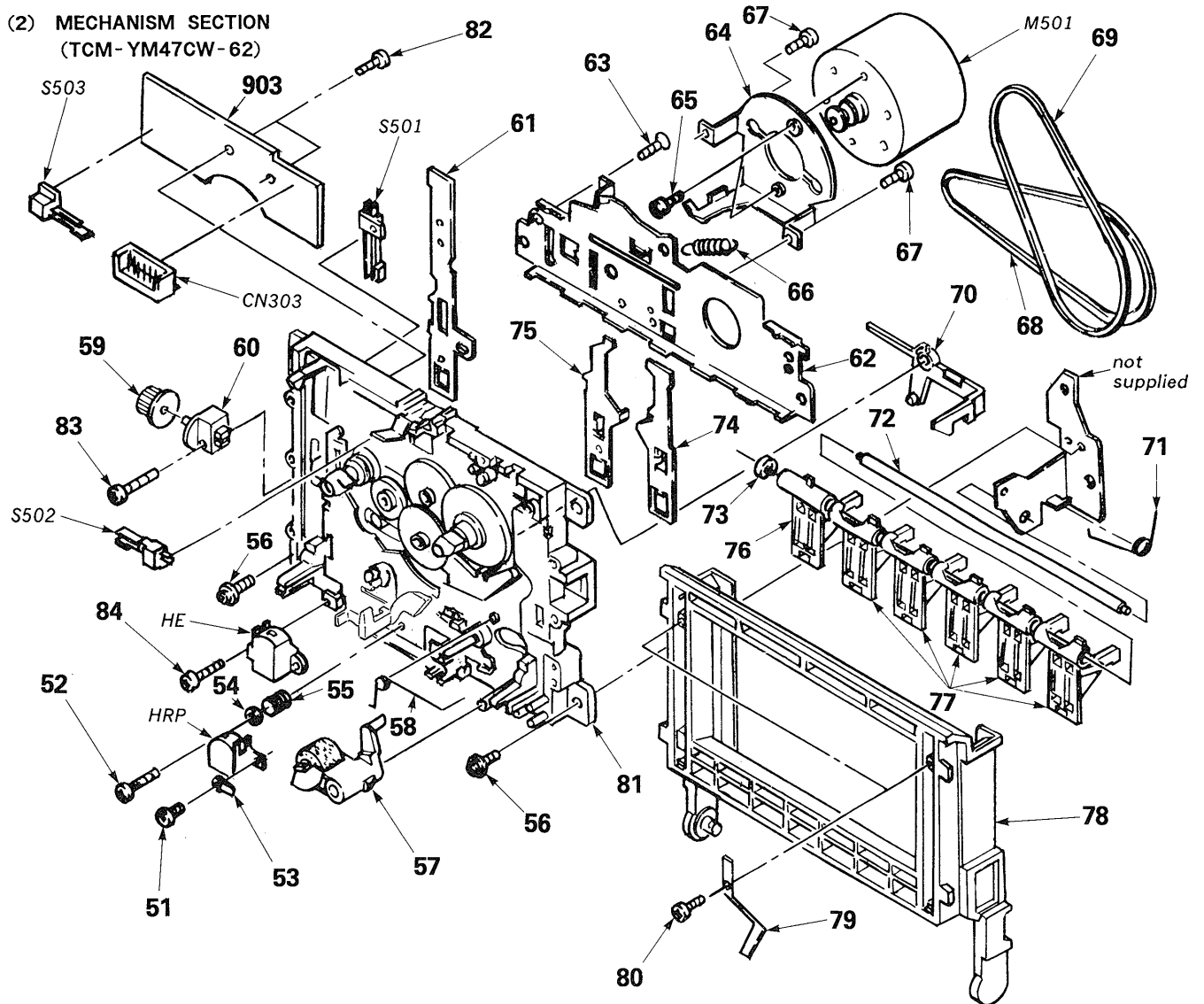

No.	Part No.	Description	Remarks	No.	Part No.	Description	Remarks
51	7-621-255-15	SCREW +P 2X3		72	*3-392-139-01	SHAFT	
52	7-621-255-55	SCREW, TOTSU P 2X8		73	7-624-104-04	STOP RING 2.0, TYPE -E	
53	3-390-817-01	LUG		74	*4-894-988-01	FF LEVER W	
54	3-390-823-01	WASHER, F		75	*4-894-990-01	REW LEVER	
55	4-894-955-01	C SPRING		76	3-392-147-01	LEVER (R), BUTTON	
56	7-687-501-31	SCREW, TOTSU PTTWH 2.6X6		77	3-392-140-01	LEVER, BUTTON	
57	3-390-805-01	ROLLER ASSY, PINCH		78	3-390-801-01	CASE, CASSETTE	
58	4-894-967-01	SPRING		79	4-894-951-01	KEEP PLATE	
59	3-392-144-01	DAMPER, GEAR		80	7-685-103-19	SCREW +P 2X5 TYPE2 NON-SLIT	
60	*3-392-143-01	HOLDER, GEAR		81	4-894-968-01	CHASSIS ASSY	
61	*4-894-994-01	REC LEVER		82	7-685-133-19	SCREW +P 2.6X6 TYPE1	
62	*4-894-977-01	BACK PLATE		83	7-685-856-01	SCREW +BVTT 2X12 (S)	
63	7-685-234-14	SCREW +KTP 2.6X8 TYPE2 NON-SLIT		84	7-685-852-01	SCREW, BVTT 2X5	
64	*3-390-814-01	BRACKET, MOTOR		903	*1-628-420-11	PC BOARD, MAIN (A)	
65	7-628-253-90	SCREW +PS 2.6X4		CN303	*1-564-499-11	PIN, CONNECTOR 6P	
66	3-390-809-01	SPRING		HE	1-543-261-11	HEAD, ERASE (886-01-24)	
67	7-621-255-25	SCREW +PTT 2X4 (S)		HRP	1-543-424-21	HEAD, MAGNETIC (REC/PB)	
68	3-390-885-01	BELT, SQUARE		M501	X-3390-802-1	MOTOR ASSY	
69	3-390-816-01	BELT, SQUARE		S501	1-570-715-11	SWITCH, LEAF	
70	*4-894-980-01	EJECT ARM		S502	1-570-716-11	SWITCH, LEAF	
71	3-392-142-01	SPRING		S503	1-571-714-11	SWITCH, LEAF	

SECTION 6

ELECTRICAL PARTS LIST

NOTE:

- Due to standardization, replacements in the parts list may be different from the parts specified in the diagrams or the components used on the set.
- Items marked "★" are not stocked since they are seldom required for routine service. Some delay should be anticipated when ordering these items.
- If there are two or more same circuits in a set such as a stereophonic machine, only typical circuit parts may be indicated and capacitors and resistors in other same circuits may be omitted.

CAPACITORS:

MF: μ F, PF: μ μF.

RESISTORS

- All resistors are in ohms.
- F: nonflammable

COILS

- MMH: mH, UH: μ H

SEMICONDUCTORS

In each case, U: μ , for example:

UA....: μ A...., UPA....: μ PA....,

UPC....: μ PC, UPD....: μ PD...

The components identified by mark Δ or dotted line with mark Δ are critical for safety. Replace only with part number specified.

Les composants identifiés par une marque Δ sont critiques pour la sécurité. Ne les remplacer que par une pièce portant le numéro spécifié.

Ref.No.	Part No.	Description					Ref.No.	Part No.	Description				
901	Δ 1-551-188-XX	(E).....CORD, POWER					C223	1-123-875-11	ELECT	10MF	20%	50V	
	Δ 1-551-506-XX	(US,Canadian)...CORD, POWER					C231	1-162-291-31	CERAMIC	560PF	10%	50V	
	Δ 1-555-795-00	(AEP,West Germany) ...CORD, POWER, EULO PLUG					C232	1-130-487-00	MYLAR	0.022MF	5%	50V	
	Δ 1-556-035-00	(UK).....CORD, POWER					C233	1-124-273-00	ELECT	3.3MF	20%	50V	
902	*A-2056-442-A	MOUNTED PCB, AUDIO					C234	1-161-377-00	CERAMIC	0.0047MF	30%	16V	
	*1-630-283-11	PC BOARD, AUDIO					C241	1-124-902-00	ELECT	0.47MF	20%	50V	
903	*1-628-420-11	PC BOARD, MAIN (A)					C242	1-124-927-11	ELECT	4.7MF	20%	50V	
C111	1-123-875-11	ELECT	10MF	20%	50V		C243	1-123-875-11	ELECT	10MF	20%	50V	
C112	1-123-382-00	ELECT	3.3MF	20%	50V		C250	1-136-273-91	FILM	75PF	5%	630V	
C113	1-130-479-00	MYLAR	0.0047MF	5%	50V		C251	1-162-284-31	CERAMIC	150PF	10%	50V	
C114	1-136-173-00	FILM	0.47MF	5%	50V		C271	1-123-875-11	ELECT	10MF	20%	50V	
C115	1-136-167-00	FILM	0.15MF	5%	50V		C272	1-124-925-11	ELECT	2.2MF	20%	50V	
C116	1-136-155-00	FILM	0.015MF	5%	50V		C311	1-124-925-11	ELECT	2.2MF	20%	50V	
C117	1-136-169-00	FILM	0.22MF	5%	50V		C331	1-124-443-00	ELECT	100MF	20%	10V	
C118	1-136-163-00	FILM	0.068MF	5%	50V		C332	1-124-443-00	ELECT	100MF	20%	10V	
C119	1-136-161-00	FILM	0.047MF	5%	50V		C361	1-161-379-00	CERAMIC	0.01MF	30%	25V	
C120	1-130-481-00	MYLAR	0.0068MF	5%	50V		C371	1-123-875-11	ELECT	10MF	20%	50V	
C121	1-136-153-00	FILM	0.01MF	5%	50V		C381	1-136-562-11	FILM	0.0082MF	5%	630V	
C122	1-123-875-11	ELECT	10MF	20%	50V		C382	1-124-925-11	ELECT	2.2MF	20%	50V	
C123	1-123-875-11	ELECT	10MF	20%	50V		C383	1-130-482-00	MYLAR	0.0082MF	5%	50V	
C131	1-162-291-31	CERAMIC	560PF	10%	50V		C384	1-130-478-00	MYLAR	0.0039MF	5%	50V	
C132	1-130-487-00	MYLAR	0.022MF	5%	50V		C385	1-130-478-00	MYLAR	0.0039MF	5%	50V	
C133	1-124-273-00	ELECT	3.3MF	20%	50V		C386	1-124-902-00	ELECT	0.47MF	20%	50V	
C134	1-161-377-00	CERAMIC	0.0047MF	30%	16V		C387	1-124-927-11	ELECT	4.7MF	20%	50V	
C141	1-124-902-00	ELECT	0.47MF	20%	50V		C388	1-126-233-11	ELECT	22MF	20%	50V	
C142	1-124-927-11	ELECT	4.7MF	20%	50V		C389	1-123-382-00	ELECT	3.3MF	20%	50V	
C143	1-123-875-11	ELECT	10MF	20%	50V		C390	1-126-101-11	ELECT	100MF	20%	16V	
C150	1-136-273-91	FILM	75PF	5%	630V		C401	1-124-557-11	ELECT	1000MF	20%	25V	
C151	1-162-284-31	CERAMIC	150PF	10%	50V		C402	1-124-557-11	ELECT	1000MF	20%	25V	
C171	1-123-875-11	ELECT	10MF	20%	50V		C403	1-124-477-11	ELECT	47MF	20%	25V	
C172	1-124-925-11	ELECT	2.2MF	20%	50V		C404	1-124-477-11	ELECT	47MF	20%	25V	
C211	1-123-875-11	ELECT	10MF	20%	50V		C405	1-124-443-00	ELECT	100MF	20%	10V	
C212	1-123-382-00	ELECT	3.3MF	20%	50V		C406	1-124-472-11	ELECT	470MF	20%	10V	
C213	1-130-479-00	MYLAR	0.0047MF	5%	50V		C407	1-124-604-00	ELECT	330MF	20%	10V	
C214	1-136-173-00	FILM	0.47MF	5%	50V		C408	1-126-176-11	ELECT	220MF	20%	10V	
C215	1-136-167-00	FILM	0.15MF	5%	50V		C409	1-126-176-11	ELECT	220MF	20%	10V	
C216	1-136-155-00	FILM	0.015MF	5%	50V		C501	1-124-927-11	ELECT	4.7MF	20%	50V	
C217	1-136-169-00	FILM	0.22MF	5%	50V		C502	1-124-927-11	ELECT	4.7MF	20%	50V	
C218	1-136-163-00	FILM	0.068MF	5%	50V		C503	1-124-927-11	ELECT	4.7MF	20%	50V	
C219	1-136-161-00	FILM	0.047MF	5%	50V		CN303	*1-564-499-11	PIN, CONNECTOR 6P				
C220	1-130-481-00	MYLAR	0.0068MF	5%	50V		CNE301	*1-564-509-11	PLUG, CONNECTOR 6P				
C221	1-136-153-00	FILM	0.01MF	5%	50V		CNE302	*1-564-505-11	PLUG, CONNECTOR 2P				
C222	1-123-875-11	ELECT	10MF	20%	50V		CT381	1-141-225-00	CAP, TUNING, TRIMAR				

Ref.No.	Part No.	Description	Ref.No.	Part No.	Description
D171	8-719-304-38	DIODE SEL4414E-D (PEAK LEVEL METER)	Q401	8-729-209-15	TRANSISTOR 2SD2012
D172	8-719-304-38	DIODE SEL4414E-D (PEAK LEVEL METER)	Q404	8-729-820-15	TRANSISTOR 2SB1274
D173	8-719-304-38	DIODE SEL4414E-D (PEAK LEVEL METER)	Q406	8-729-119-76	TRANSISTOR 2SA1175HFE
D174	8-719-304-32	DIODE SEL4214S (PEAK LEVEL METER)	R101	1-249-435-11	CARBON 33K 5% 1/4W
D175	8-719-304-32	DIODE SEL4214S (PEAK LEVEL METER)	R102	1-249-417-11	CARBON 1K 5% 1/4W
D176	8-719-304-38	DIODE SEL4414E-D (PEAK LEVEL METER)	R103	1-249-421-11	CARBON 2.2K 5% 1/4W
D271	8-719-304-38	DIODE SEL4414E-D (PEAK LEVEL METER)	R112	1-249-423-11	CARBON 3.3K 5% 1/4W
D272	8-719-304-38	DIODE SEL4414E-D (PEAK LEVEL METER)	R113	1-249-422-11	CARBON 2.7K 5% 1/4W
D273	8-719-304-38	DIODE SEL4414E-D (PEAK LEVEL METER)	R114	1-247-846-11	CARBON 4.3K 5% 1/4W
D274	8-719-304-32	DIODE SEL4214S (PEAK LEVEL METER)	R115	1-247-840-00	CARBON 2.4K 5% 1/4W
D275	8-719-304-32	DIODE SEL4214S (PEAK LEVEL METER)	R116	1-247-822-11	CARBON 430 5% 1/4W
D276	8-719-304-38	DIODE SEL4414E-D (PEAK LEVEL METER)	R117	1-249-427-11	CARBON 6.8K 5% 1/4W
D381	8-719-000-26	DIODE US1060M	R118	1-249-415-11	CARBON 680 5% 1/4W
D382	8-719-000-26	DIODE US1060M	R119	1-249-429-11	CARBON 10K 5% 1/4W
D383	8-719-000-26	DIODE US1060M	R121	1-249-417-11	CARBON 1K 5% 1/4W
D384	8-719-000-26	DIODE US1060M	R131	1-247-889-00	CARBON 270K 5% 1/4W
D385	8-719-000-26	DIODE US1060M	R132	1-249-404-00	CARBON 82 5% 1/4W
D386	8-719-000-26	DIODE US1060M	R133	1-247-882-11	CARBON 130K 5% 1/4W
D387	8-719-000-26	DIODE US1060M	R134	1-249-426-11	CARBON 5.6K 5% 1/4W
D388	8-719-302-45	DIODE SEL1210S (REC IND)	R135	1-249-430-11	CARBON 12K 5% 1/4W
D389	8-719-000-78	DIODE UZL-7L2	R136	1-249-431-11	CARBON 15K 5% 1/4W
D401	8-719-200-02	DIODE 10E2	R137	1-247-887-00	CARBON 220K 5% 1/4W
D402	8-719-200-02	DIODE 10E2	R141	1-249-428-11	CARBON 8.2K 5% 1/4W
D403	8-719-200-02	DIODE 10E2	R142	1-249-421-11	CARBON 2.2K 5% 1/4W
D404	8-719-200-02	DIODE 10E2	R143	1-249-430-11	CARBON 12K 5% 1/4W
D405	8-719-000-78	DIODE UZL-7L2	R162	1-249-429-11	CARBON 10K 5% 1/4W
HE	1-543-261-11	HEAD, ERASE (886-01-24)	R163	1-247-860-11	CARBON 16K 5% 1/4W
HRP	1-543-424-21	HEAD, MAGNETIC (REC/PB)	R164	1-249-430-11	CARBON 12K 5% 1/4W
IC171	8-759-917-42	IC IR2E31A	R165	1-249-409-11	CARBON 220 5% 1/4W
IC271	8-759-917-42	IC IR2E31A	R166	1-249-432-11	CARBON 18K 5% 1/4W
IC311	8-752-018-70	IC CX20187	R167	1-249-423-11	CARBON 3.3K 5% 1/4W
IC331	8-759-111-44	IC UPC4570C-1	R168	1-249-421-11	CARBON 2.2K 5% 1/4W
IC341	8-752-033-61	IC CXA1198AP	R171	1-249-441-11	CARBON 100K 5% 1/4W
IC361	8-759-600-02	IC M5218L	R201	1-249-435-11	CARBON 33K 5% 1/4W
IC381	8-759-601-10	IC M4011BP	R202	1-249-417-11	CARBON 1K 5% 1/4W
J301	1-565-259-11	JACK, PIN 4P (LINE)	R203	1-249-421-11	CARBON 2.2K 5% 1/4W
J302	1-507-981-11	JACK (LARGE TYPE) (HEADPHONES)	R212	1-249-423-11	CARBON 3.3K 5% 1/4W
L142	1-410-780-11	INDUCTOR 27MMH	R213	1-249-422-11	CARBON 2.7K 5% 1/4W
L242	1-410-780-11	INDUCTOR 27MMH	R214	1-247-846-11	CARBON 4.3K 5% 1/4W
LPF101	1-235-980-11	FILTER, LOW PASS	R215	1-247-840-00	CARBON 2.4K 5% 1/4W
LPF201	1-235-980-11	FILTER, LOW PASS	R216	1-247-822-11	CARBON 430 5% 1/4W
M501	X-3390-802-1	MOTOR ASSY	R217	1-249-427-11	CARBON 6.8K 5% 1/4W
Q131	8-729-900-61	TRANSISTOR DTC114ES	R218	1-249-415-11	CARBON 680 5% 1/4W
Q141	8-729-900-74	TRANSISTOR DTC143TS	R219	1-249-429-11	CARBON 10K 5% 1/4W
Q161	8-729-119-78	TRANSISTOR 2SC2785HFE	R221	1-249-417-11	CARBON 1K 5% 1/4W
Q231	8-729-900-61	TRANSISTOR DTC114ES	R231	1-247-889-00	CARBON 270K 5% 1/4W
Q241	8-729-900-74	TRANSISTOR DTC143TS	R232	1-249-404-00	CARBON 82 5% 1/4W
Q261	8-729-119-78	TRANSISTOR 2SC2785HFE	R233	1-247-882-11	CARBON 130K 5% 1/4W
Q381	8-729-194-57	TRANSISTOR 2SC945P	R234	1-249-426-11	CARBON 5.6K 5% 1/4W
Q382	8-729-194-57	TRANSISTOR 2SC945P	R235	1-249-430-11	CARBON 12K 5% 1/4W
Q383	8-729-281-52	TRANSISTOR 2SC1815Y	R236	1-249-431-11	CARBON 15K 5% 1/4W
Q384	8-729-900-65	TRANSISTOR DTA144ES	R237	1-247-887-00	CARBON 220K 5% 1/4W
Q388	8-729-115-27	TRANSISTOR BN1L3Z	R241	1-249-428-11	CARBON 8.2K 5% 1/4W
Q389	8-729-900-61	TRANSISTOR DTA114ES	R242	1-249-421-11	CARBON 2.2K 5% 1/4W
			R243	1-249-430-11	CARBON 12K 5% 1/4W
			R262	1-249-429-11	CARBON 10K 5% 1/4W
			R263	1-247-860-11	CARBON 16K 5% 1/4W

Ref.No.	Part No.	Description			
R264	1-249-430-11	CARBON	12K	5%	1/4W
R265	1-249-409-11	CARBON	220	5%	1/4W
R266	1-249-432-11	CARBON	18K	5%	1/4W
R267	1-249-423-11	CARBON	3.3K	5%	1/4W
R268	1-249-421-11	CARBON	2.2K	5%	1/4W
R271	1-249-441-11	CARBON	100K	5%	1/4W
R311	1-249-429-11	CARBON	10K	5%	1/4W
R312	1-249-429-11	CARBON	10K	5%	1/4W
R313	1-215-469-00	METAL	100K	1%	1/6W
R314	1-249-441-11	CARBON	100K	5%	1/4W
R331	1-249-409-11	CARBON	220	5%	1/4W
R332	1-249-409-11	CARBON	220	5%	1/4W
R342	1-247-864-11	CARBON	24K	5%	1/4W
R371	1-249-407-11	CARBON	150	5%	1/4W
R372	1-249-406-11	CARBON	120	5%	1/4W
R381	1-249-393-11	CARBON	10	5%	1/4W
R382	1-249-433-11	CARBON	22K	5%	1/4W
R383	1-249-433-11	CARBON	22K	5%	1/4W
R384	1-249-429-11	CARBON	10K	5%	1/4W
R385	1-249-429-11	CARBON	10K	5%	1/4W
R386	1-249-433-11	CARBON	22K	5%	1/4W
R387	1-249-411-11	CARBON	330	5%	1/4W
R388	1-249-417-11	CARBON	1K	5%	1/4W
R389	1-249-437-11	CARBON	47K	5%	1/4W
R390	1-249-425-11	CARBON	4.7K	5%	1/4W
R391	1-249-429-11	CARBON	10K	5%	1/4W
R392	1-249-433-11	CARBON	22K	5%	1/4W
R393	1-249-437-11	CARBON	47K	5%	1/4W
R394	1-249-441-11	CARBON	100K	5%	1/4W
R395	1-249-429-11	CARBON	10K	5%	1/4W
R396	1-249-423-11	CARBON	3.3K	5%	1/4W
R397	1-249-437-11	CARBON	47K	5%	1/4W
R398	1-249-411-11	CARBON	330	5%	1/4W
R401	1-249-413-11	CARBON	470	5%	1/4W
R402	1-249-413-11	CARBON	470	5%	1/4W
R403	1-249-413-11	CARBON	470	5%	1/4W
R404	1-249-413-11	CARBON	470	5%	1/4W
R408	1-249-419-11	CARBON	1.5K	5%	1/4W
R409	1-249-418-11	CARBON	1.2K	5%	1/4W
R501	1-249-439-11	CARBON	68K	5%	1/4W
R502	1-249-436-11	CARBON	39K	5%	1/4W
R503	1-249-441-11	CARBON	100K	5%	1/4W
R504	1-247-882-11	CARBON	130K	5%	1/4W
R505	1-247-876-11	CARBON	75K	5%	1/4W
R506	1-249-438-11	CARBON	56K	5%	1/4W
R507	1-247-876-11	CARBON	75K	5%	1/4W
R508	1-249-438-11	CARBON	56K	5%	1/4W
R509	1-249-439-11	CARBON	68K	5%	1/4W
R510	1-247-878-00	CARBON	91K	5%	1/4W
R511	1-247-878-00	CARBON	91K	5%	1/4W
R512	1-247-885-00	CARBON	180K	5%	1/4W
R513	1-247-876-11	CARBON	75K	5%	1/4W
R514	1-249-438-11	CARBON	56K	5%	1/4W
R515	1-247-874-11	CARBON	62K	5%	1/4W
R516	1-249-438-11	CARBON	56K	5%	1/4W
R517	1-247-881-00	CARBON	120K	5%	1/4W
R518	1-247-887-00	CARBON	220K	5%	1/4W
R519	1-247-903-00	CARBON	1M	5%	1/4W

Ref.No.	Part No.	Description
RV131	1-228-994-00	RES, ADJ, CARBON 10K
RV141	1-228-995-00	RES, ADJ, CARBON 22K
RV231	1-228-994-00	RES, ADJ, CARBON 10K
RV241	1-228-995-00	RES, ADJ, CARBON 22K
RV301	1-238-262-11	RES, VAR, CARBON 20K/20K (REC LEVEL)
RV302	1-238-263-11	RES, VAR, CARBON 5K/5K (BALANCE)
RY381	1-515-688-11	RELAY
S301	1-571-292-11	SWITCH, PUSH (1 KEY) (DOLBY ON/OFF)
S302	1-571-292-11	SWITCH, PUSH (1 KEY) (DOLBY B/C)
S341	1-571-879-11	SWITCH, PUSH (3 KEY) (TAPE SELECT)
S401	1-570-393-21	SWITCH, PUSH (1 KEY) (POWER)
S501	1-570-715-11	SWITCH, LEAF
S502	1-570-716-11	SWITCH, LEAF
S503	1-571-714-11	SWITCH, LEAF
S504	1-552-535-00	(E)...SWITCH, POWER & VOLTAGE CHANGE
SPK101	1-235-186-00	ENCAPSULATED COMPONENT
SPK201	1-235-186-00	ENCAPSULATED COMPONENT
T381	1-433-303-11	TRANSFORMER, BIAS OSCILLATION
T401	1-449-388-11	(E).....TRANSFORMER, POWER
T401	1-449-390-11	(AEP, West Germany, UK)TRANSFORMER, POWER
T401	1-449-593-11	(US, Canadian).....TRANSFORMER, POWER

ACCESSORY & PACKING MATERIAL

1-526-565-12	(E)...AC PLUG ADAPTOR
1-559-533-11	CORD, CONNECTION
*3-332-556-81	INDIVIDUAL CARTON
*3-349-037-01	CUSHION
3-703-450-01	(US)...INSTRUCTION
3-750-353-11	(AEP, E).....MANUAL, INSTRUCTION (ENGLISH, FRENCH, SPANISH, PORTUGUESE)
3-750-353-21	(US, Canadian, UK)...MANUAL, INSTRUCTION (ENGLISH)
3-750-353-31	(Canadian)...MANUAL, INSTRUCTION (FRENCH)
3-750-353-41	(AEP).....MANUAL, INSTRUCTION (GERMAN, DUTCH, SWEDISH, ITALIAN)
3-750-353-51	(West Germany)...MANUAL, INSTRUCTION (GERMAN)

The components identified by mark Δ or dotted line with mark Δ are critical for safety. Replace only with part number specified.

Les composants identifiés par une marque Δ sont critiques pour la sécurité. Ne les remplacer que par une pièce portant le numéro spécifié.

TC-FX110

SONY® SERVICE MANUAL

*US Model
Canadian Model
AEP Model
UK Model
E Model*

SUPPLEMENT-1

File this supplement with the service manual.

Subject: exploded view mechanism section

- The “Mechanism” section (page 13) is revised due to addition of the service parts.

SECTION 5 EXPLODED VIEWS

NOTE:

- -XX, -X mean standardized parts, so they may have some differences from the original one.
- Color Indication of Appearance Parts
Example :
KNOB, BALANCE (WHITE)...(RED)
↑ ↑
Parts color Cabinet's color
- Items marked "*" are not stocked since they are seldom required for routine service. Some delay should be anticipated when ordering these items.
- The mechanical parts with no reference number in the exploded views are not supplied.

**(2) MECHANISM SECTION
(TCM- YM47CW- 62)**

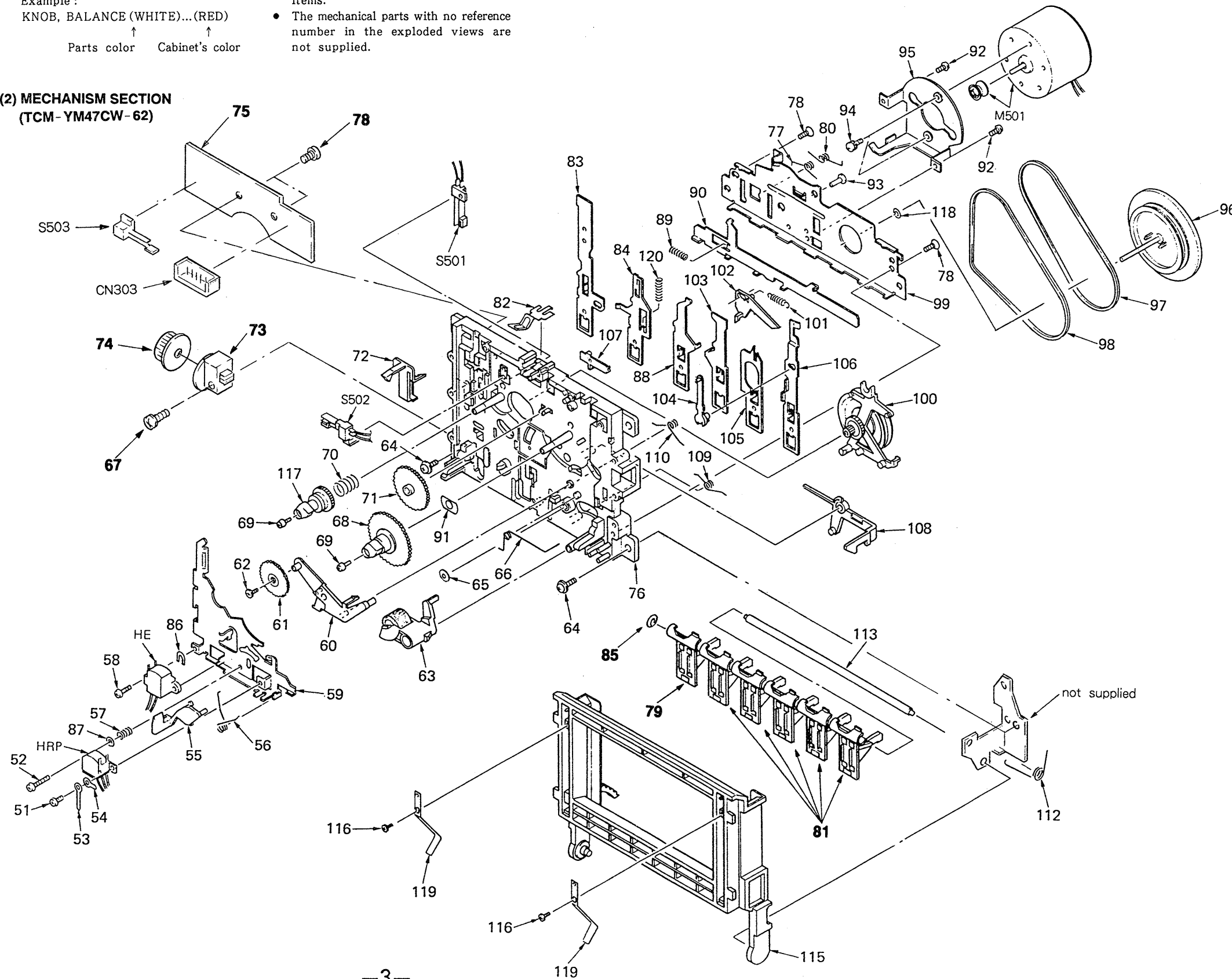

Ref. No.	Part No.	Description	Remarks
51	7-621-255-15	SCREW +P 2X3	
52	7-621-255-55	SCREW, TOTSU P 2X8	
* 53	3-390-819-01	LUG	
54	3-390-817-01	LUG	
55	4-894-956-01	TAPE SENSOR	
56	3-390-804-01	SPRING, PINCH ARM	
57	4-894-955-01	C SPRING	
58	7-685-852-01	SCREW, BVTT 2X5 (S)	
* 59	4-894-957-01	HEAD BASE B	
60	4-894-962-01	IDLER ARM	
61	4-894-961-01	IDLER GEAR	
62	4-894-960-01	BUSH	
63	3-390-805-01	ROLLER ASSY, PINCH	
64	7-621-770-67	SCREW, TOTSU PTTWH 2.6X6	
65	4-894-969-01	N WASHER	
66	4-894-967-01	SPRING	
67	7-621-772-68	SCREW +BVTT 2X12 (S)	
68	4-894-963-01	T REEL ASSY	
69	3-390-803-01	BUSHING (D)	
70	4-894-954-01	C SPRING	
71	4-894-964-01	F GEAR	
72	4-894-958-01	INTERLOCK ARM	
* 73	3-392-143-01	HOLDER, GEAR	
74	3-392-144-01	DAMPER, GEAR	
* 75	1-628-420-11	PC BOARD, MAIN (A)	
76	4-894-968-01	CHASSIS ASSY	
77	4-894-978-01	SPRING	
78	7-685-133-19	SCREW +P 2.6X6 TYPE2	
79	3-392-147-01	LEVER (R), BUTTON	
80	4-894-979-01	SPRING	
81	3-392-140-01	LEVER, BUTTON	
82	4-894-966-01	SPRING	
83	4-894-994-01	REC LEVER	
84	3-390-810-01	LEVER, PLAY	
85	7-624-104-04	STOP RING 2.0, TYPE -E	
86	3-390-821-01	SPACER	
87	3-390-823-01	WASHER, F	
* 88	4-894-990-01	REW LEVER	
89	4-894-983-01	C SPRING	
* 90	4-894-984-01	FUNCTION LEVER	
91	3-390-820-01	SPRING, LEAF	
92	7-621-255-25	SCREW +PTT 2X4 (S)	
93	3-390-822-01	BUSHING (C)	
94	7-628-253-90	SCREW +PS 2.6X4	
* 95	3-390-814-01	BRACKET, MOTOR	
96	3-390-806-11	FW ASSY	
97	3-390-807-01	BELT, SQUARE	
98	3-561-892-00	BELT, SQUARE	
* 99	4-894-977-01	BACK PLATE	
100	4-894-997-01	POWER ARM ASSY	
101	3-390-809-01	SPRING	
102	4-894-982-01	S ARM	
* 103	4-894-988-01	FF LEVER W	
104	4-894-985-01	PAUSE ARM	
* 105	4-894-987-01	S. E LEVER	
* 106	4-894-986-01	PAUSE LEVER	
107	3-390-811-01	LEVER, REC STOP	
108	4-894-980-01	EJECT ARM	
109	4-894-989-01	SPRING	
110	4-894-999-01	SPRING	
112	3-392-142-01	SPRING	
* 113	3-392-139-01	SHAFT	
115	3-390-801-01	CASE, CASSETTE	
116	7-685-103-19	SCREW +P 2X5 TYPE2 NON-SLIT	
117	4-894-953-01	S REEL	
118	4-894-976-01	P WASHER	
119	4-894-951-01	KEEP PLATE	
120	3-390-827-01	SPRING	
* CN303	1-564-499-11	PIN, CONNECTOR 6P	
HE	1-543-261-11	HEAD, ERASE (886-01-24)	
HRP	1-543-424-21	HEAD, MAGNETIC (REC/PB)	
M501	X-3390-802-1	MOTOR ASSY	
S501	1-572-394-11	SWITCH, LEAF	
S502	1-571-555-11	SWITCH, LEAF	
S503	1-571-714-11	SWITCH, LEAF	